

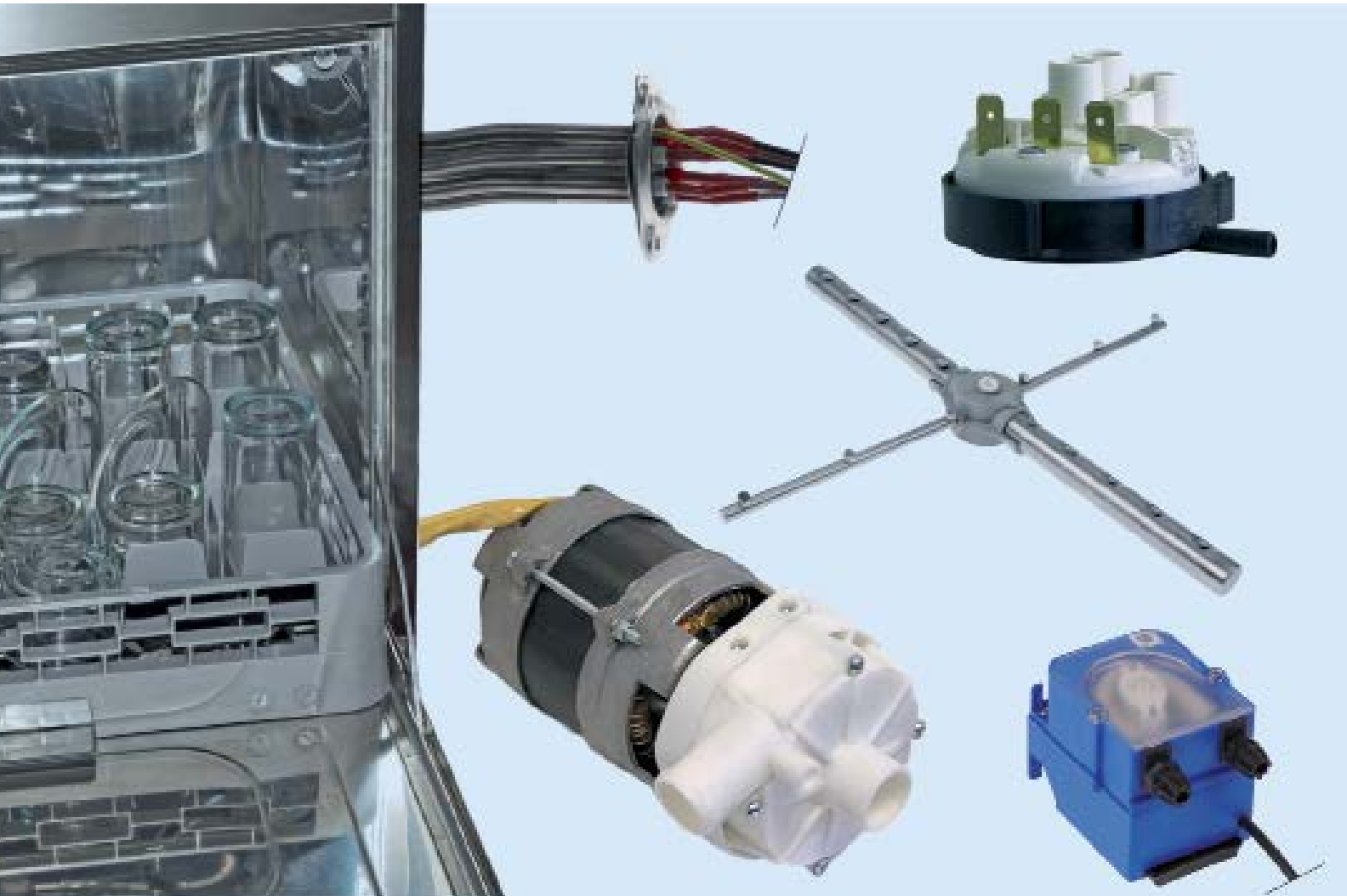

Spare Parts for Dishwashing



Spare parts suitable for

UNIVER-BAR

2018

Find the complete and up-to-date range of products in our GEV Webshop



heating elements

immersion heating elements

3 hole flange ø47.5mm

GEV No.	416318	Ref. No.	3010
description	heating element 3000W 230V mounting ø 47.5mm heating circuits 3 L 265mm W 32mm H 33mm number of thermostat sleeves 1 thermostat sleeves ø 6.5mm length thermostat sleeves 235mm thermostat sleeve eccentric, non clinging tube ø 6.5mm connection M4		
accessories for	416318		
	GEV No.	510408	Ref. No. 4011
	O-ring EPDM thickness 5.34mm ID ø 47mm Qty 1 pcs		
	GEV No.	510562	Ref. No. —
	O-ring silicone thickness 5.34mm ID ø 47mm Qty 1 pcs		

GEV No.	416329	Ref. No.	3371
description	heating element 4500W 230V mounting ø 47.5mm heating circuits 3 L 370mm W 33mm H 37mm number of thermostat sleeves 1 thermostat sleeves ø 7mm length thermostat sleeves 235mm thermostat sleeve eccentric, non clinging tube ø 6.5mm connection M4 3 hole flange		
spare parts for	416329		
	GEV No.	510408	Ref. No. 4011
	O-ring EPDM thickness 5.34mm ID ø 47mm Qty 1 pcs		

with compression flange 62 x 26mm

GEV No.	415266	Ref. No.	2011
description	heating element 2000W 230V heating circuits 1 compression flange flange 62x26mm L 300mm W 41mm Hmm connection male faston 6.3mm tube ø 6.3mm immersion heater		

GEV No.	416307	Ref. No.	1532
description	heating element 2000W 230V heating circuits 1 flange 62x26mm L 270mm W 42mm H 27mm tube ø 6mm connection male faston 6.3mm		



with round flange ø47.5mm

GEV No.	416306	Ref. No.	2010
description	heating element 2000W 220V heating circuits 1 mounting ø 47.5mm L 270mm W 38mm H 22mm connection M4 tube ø 6.25mm thermostat sleeves ø 7.5mm number of thermostat sleeves 1 length thermostat sleeves 200mm thermostat sleeve eccentric, non clinging		
accessories for	416306		
	GEV No.	510408	Ref. No. 4011
	O-ring EPDM thickness 5.34mm ID ø 47mm Qty 1 pcs		
	GEV No.	510562	Ref. No. —
	O-ring silicone thickness 5.34mm ID ø 47mm Qty 1 pcs		
	GEV No.	520235	Ref. No. —
	3 hole flange hole distance 70.5mm perforation ø 6.5mm ID ø 53.5mm		
	GEV No.	520236	Ref. No. —
	flange for heating element ID ø 50mm ED ø 90mm H 3mm		
	GEV No.	550002	Ref. No. 3136
	tension strap H 10mm L 21mm W 10mm hole ø 6.5mm for heating element		
	GEV No.	550362	Ref. No. —
	blind flange ø 64mm mounting ø 47.5mm		



GEV No.	416319	Ref. No.	4599
description	heating element 2000W 230V heating circuits 1 mounting ø 47.5mm L 275mm W 39mm H 35mm connection M4 H1 21mm H2 14mm		
spare parts for	416319		
	GEV No.	510408	Ref. No. 4011
	O-ring EPDM thickness 5.34mm ID ø 47mm Qty 1 pcs		
accessories for	416319		
	GEV No.	510562	Ref. No. —
	O-ring silicone thickness 5.34mm ID ø 47mm Qty 1 pcs		
	GEV No.	520235	Ref. No. —
	3 hole flange hole distance 70.5mm perforation ø 6.5mm ID ø 53.5mm		
	GEV No.	520236	Ref. No. —
	flange for heating element ID ø 50mm ED ø 90mm H 3mm		

Table continues overleaf



accessories for	416319		
	GEV No.	550002	Ref. No. 3136
	tension strap H 10mm L 21mm W 10mm hole ø 6.5mm for heating element		
	GEV No.	550362	Ref. No. —
	blind flange ø 64mm mounting ø 47.5mm		

			
GEV No.	416327	Ref. No.	4552
description	heating element 3000W 230V heating circuits 3 mounting ø 47.5mm L 280mm W 28mm H 60mm connection M4 tube ø 6.25mm H1 24mm H2 36mm		
accessories for	416327		
	GEV No.	510408	Ref. No. 4011
	O-ring EPDM thickness 5.34mm ID ø 47mm Qty 1 pcs		
	GEV No.	510562	Ref. No. —
	O-ring silicone thickness 5.34mm ID ø 47mm Qty 1 pcs		
	GEV No.	520235	Ref. No. —
	3 hole flange hole distance 70.5mm perforation ø 6.5mm ID ø 53.5mm		
	GEV No.	520236	Ref. No. —
	flange for heating element ID ø 50mm ED ø 90mm H 3mm		
	GEV No.	550002	Ref. No. 3136
	tension strap H 10mm L 21mm W 10mm hole ø 6.5mm for heating element		
	GEV No.	550362	Ref. No. —
	blind flange ø 64mm mounting ø 47.5mm		

			
GEV No.	416317	Ref. No.	4551
description	heating element 6000W 230V heating circuits 3 mounting ø 47.5mm L 400mm W 36mm H 36mm connection M4 tube ø 6.2mm thermostat sleeves ø 7mm number of thermostat sleeves 1 length thermostat sleeves 235mm thermostat sleeve eccentric, non clinging		
spare parts for	416317		
	GEV No.	510408	Ref. No. 4011
	O-ring EPDM thickness 5.34mm ID ø 47mm Qty 1 pcs		
	GEV No.	510562	Ref. No. —
	O-ring silicone thickness 5.34mm ID ø 47mm Qty 1 pcs		
	GEV No.	520235	Ref. No. —
	3 hole flange hole distance 70.5mm perforation ø 6.5mm ID ø 53.5mm		
	GEV No.	520236	Ref. No. —
	flange for heating element ID ø 50mm ED ø 90mm H 3mm		
	GEV No.	550002	Ref. No. 3136
	tension strap H 10mm L 21mm W 10mm hole ø 6.5mm for heating element		
	GEV No.	550362	Ref. No. —
	blind flange ø 64mm mounting ø 47.5mm		

accessories

			
GEV No.	550002	Ref. No.	3136
description	tension strap H 10mm L 21mm W 10mm hole ø 6.5mm for heating element		

thermostats

bi-metal thermostats

safety bi-metal thermostats

			
GEV No.	390455	Ref. No.	4751
description	bi-metal safety thermostat hole distance 40mm switch-off temp. 100°C 2NC 2-pole 16A connection F6.3 2 hole fixing		

control and safety thermostats

IMIT / TEMPOMATIC / ARTHERMO

control thermostats

			
GEV No.	375920	Ref. No.	4044
description	thermostat t.max. 90°C temperature range 0-90°C 1-pole 1CO 16A probe ø 6.5mm probe L 98mm capillary pipe 1030mm capillary pipe isolated 970mm gland nut shaft ø 6x4.6mm shaft L 16mm rotation 270° probe material copper 250V		

accessories

plunger sockets

			
GEV No.	507462	Ref. No.	1503
description	thermowell thread M10x1 ID ø 7.7mm L 115mm for probe 100mm for probe ø 7mm		



switches and momentary switches

rocker/momentary rocker switches

30x22mm



1

GEV No.	345317	Ref. No.	1519 1520
description	momentary rocker switch mounting measurements 30x22mm green 2NO 230V 16A illuminated connection male faston 6.3mm ambient temperature max. 125/55°C protection IP65 with rubber collar		



1

GEV No.	347531	Ref. No.	4069
description	rocker switch mounting measurements 30x22mm green 2NO 250V 20A illuminated 0-1 connection male faston 6.3mm ambient temperature max. 125/55°C protection IP65 with rubber collar		



1

GEV No.	346474	Ref. No.	4671
description	dummy element external size 30x22mm suitable for rocker switch		

microswitches

lever actuated



1

GEV No.	346067	Ref. No.	4074
description	microswitch with lever 250V 16A 1CO connection male faston 6.3mm ambient temperature max. 125°C lever length 30mm		



1

GEV No.	345257	Ref. No.	4095
description	microswitch with lever 250V 16A 1CO connection male faston 6.3mm L 29mm L1 33mm ambient temperature max. 120°C mounting distance 22mm actuating force: 130g lever length 31.5mm		



1

GEV No.	347607	Ref. No.	4780
description	microswitch with lever 250V 16A 1CO connection male faston 6.3mm L 77mm ambient temperature max. 85°C lever length 48mm		



1

GEV No.	346064	Ref. No.	4762
description	microswitch with lever 250V 16A 3CO connection male faston 6.3mm ambient temperature max. 125°C lever length 75mm		

timers

programme timers



1

GEV No.	360432	Ref. No.	4516
description	timer CDC 7802DV engines 2 chambers 2 operation time 1min / 2min 230V shaft ømm shaft Lmm motor type M37RN/M37LN		



1

GEV No.	360416	Ref. No.	1912 4090
description	timer CROUZET engines 1 chambers 2 operation time 120s 230V shaft ø 6x4.6mm shaft L 20mm manuf. no. 627/5280 motor type 82340		



			
1			
GEV No.	360415	Ref. No.	1507
description	timer CROUZET engines 1 chambers 4 operation time 120s 230V shaft ømm shaft Lmm manif. no. 642/5180 motor type 82340		

contactors

ALLEN BRADLEY

power contactors

			
1			
GEV No.	380468	Ref. No.	3045
description	power contactor resistive load 20A 230VAC (AC3/400V) 9A/4kW main contacts 4NO connection screw connection type 100-K09*400		

relays

power relays

with bracket mounting

			
1			
GEV No.	380815	Ref. No.	4637
description	power relays 230VAC 16A 2NO connection male faston 6.3mm flange dimensions 36x38x68mm		

electronics

PCBs

			
1			
GEV No.	403894	Ref. No.	3845
description	electronic timer L 125mm W 85mm		

			
1			
GEV No.	403895	Ref. No.	4851
description	PCB L 135mm W 85mm		

			
1			
GEV No.	692214	Ref. No.	4850
description	PCB warewashing MID15/COSMO/ERGON L 133mm W 84mm 50/60Hz voltage input 230/240 VacV 230V 17A		

solenoid valves

solenoid valves (water)









































<p>TP</p> 			
1			
GEV No.	370021	Ref. No.	4076
description	solenoid valve double straight 230VAC inlet 3/4" outlet 11.5mm DN10 TP flow regulating valve inlet white		
spare parts for	370021		
		GEV No.	371013 Ref. No. —
	solenoid coil TP 230VAC 50/60Hz		
accessories for	370021		
		GEV No.	371220 Ref. No. —
	reducer TP flow rate 3l/min red tolerance ±15%		
		GEV No.	371221 Ref. No. —
	reducer TP flow rate 5.5l/min yellow tolerance ±15%		
		GEV No.	371222 Ref. No. —
	reducer TP flow rate 6l/min grey tolerance ±15%		
		GEV No.	371223 Ref. No. —
	reducer TP flow rate 10l/min white tolerance ±15%		
		GEV No.	371224 Ref. No. —
	reducer TP flow rate 12l/min bronze tolerance ±15%		
		GEV No.	371225 Ref. No. —
	reducer TP flow rate 16l/min light brown tolerance ±15%		
		GEV No.	371226 Ref. No. —
	reducer TP flow rate 20l/min red tolerance ±15%		

Table continues overleaf

accessories for		370021		
GEV No.	Ref. No.	Ref. No.	Ref. No.	—
	371230	Ref. No.	Ref. No.	—
reducer TP flow rate 0.25l/min red tolerance ±25%				
	371231	Ref. No.	Ref. No.	—
reducer TP flow rate 0.35l/min violet tolerance ±25%				
	371232	Ref. No.	Ref. No.	—
reducer TP flow rate 0.5l/min orange tolerance ±25%				
	371233	Ref. No.	Ref. No.	—
reducer TP flow rate 0.8l/min white tolerance ±25%				
	371234	Ref. No.	Ref. No.	—
reducer TP flow rate 1l/min light blue tolerance ±25%				
	371235	Ref. No.	Ref. No.	—
reducer TP flow rate 1.2l/min brown tolerance ±25%				
	371236	Ref. No.	Ref. No.	—
reducer TP flow rate 1.5l/min light brown tolerance ±25%				
	371237	Ref. No.	Ref. No.	—
reducer TP flow rate 2.5l/min yellow tolerance ±25%				
	371238	Ref. No.	Ref. No.	—
reducer TP flow rate 3.4l/min dark green tolerance ±25%				
	371239	Ref. No.	Ref. No.	—
reducer TP flow rate 5l/min black tolerance ±25%				
	371240	Ref. No.	Ref. No.	—
reducer TP flow rate 8l/min blue tolerance ±20%				

  1			
GEV No.	370017	Ref. No.	4075
description	solenoid valve single straight 230VAC inlet 3/4" outlet 11.5mm DN10 TP p max 10bar		
spare parts for	370017		
	GEV No.	371013	Ref. No. —
solenoid coil TP 230VAC 50/60Hz			
accessories for	370017		
	GEV No.	371220	Ref. No. —
reducer TP flow rate 3l/min red tolerance ±15%			
	GEV No.	371221	Ref. No. —
reducer TP flow rate 5.5l/min yellow tolerance ±15%			
	GEV No.	371222	Ref. No. —
reducer TP flow rate 6l/min grey tolerance ±15%			
	GEV No.	371223	Ref. No. —
reducer TP flow rate 10l/min white tolerance ±15%			

accessories for		370017		
GEV No.	Ref. No.	Ref. No.	Ref. No.	—
	371224	Ref. No.	Ref. No.	—
reducer TP flow rate 12l/min bronze tolerance ±15%				
	371225	Ref. No.	Ref. No.	—
reducer TP flow rate 16l/min light brown tolerance ±15%				
	371226	Ref. No.	Ref. No.	—
reducer TP flow rate 20l/min red tolerance ±15%				
	371230	Ref. No.	Ref. No.	—
reducer TP flow rate 0.25l/min red tolerance ±25%				
	371231	Ref. No.	Ref. No.	—
reducer TP flow rate 0.35l/min violet tolerance ±25%				
	371232	Ref. No.	Ref. No.	—
reducer TP flow rate 0.5l/min orange tolerance ±25%				
	371233	Ref. No.	Ref. No.	—
reducer TP flow rate 0.8l/min white tolerance ±25%				
	371234	Ref. No.	Ref. No.	—
reducer TP flow rate 1l/min light blue tolerance ±25%				
	371235	Ref. No.	Ref. No.	—
reducer TP flow rate 1.2l/min brown tolerance ±25%				
	371236	Ref. No.	Ref. No.	—
reducer TP flow rate 1.5l/min light brown tolerance ±25%				
	371237	Ref. No.	Ref. No.	—
reducer TP flow rate 2.5l/min yellow tolerance ±25%				
	371238	Ref. No.	Ref. No.	—
reducer TP flow rate 3.4l/min dark green tolerance ±25%				
	371239	Ref. No.	Ref. No.	—
reducer TP flow rate 5l/min black tolerance ±25%				
	371240	Ref. No.	Ref. No.	—
reducer TP flow rate 8l/min blue tolerance ±20%				





















  1			
GEV No.	370016	Ref. No.	4078
description	solenoid valve single angled 230VAC inlet 3/4" outlet 14mm DN10 TP		
spare parts for	370016		
	GEV No.	371013	Ref. No. —
solenoid coil TP 230VAC 50/60Hz			

Table continues overleaf



accessories for		370016		
	GEV No.	371220	Ref. No.	—
reducer TP flow rate 3l/min red tolerance ±15%				
	GEV No.	371221	Ref. No.	—
reducer TP flow rate 5.5l/min yellow tolerance ±15%				
	GEV No.	371222	Ref. No.	—
reducer TP flow rate 6l/min grey tolerance ±15%				
	GEV No.	371223	Ref. No.	—
reducer TP flow rate 10l/min white tolerance ±15%				
	GEV No.	371224	Ref. No.	—
reducer TP flow rate 12l/min bronze tolerance ±15%				
	GEV No.	371225	Ref. No.	—
reducer TP flow rate 16l/min light brown tolerance ±15%				
	GEV No.	371226	Ref. No.	—
reducer TP flow rate 20l/min red tolerance ±15%				
	GEV No.	371230	Ref. No.	—
reducer TP flow rate 0.25l/min red tolerance ±25%				
	GEV No.	371231	Ref. No.	—
reducer TP flow rate 0.35l/min violet tolerance ±25%				
	GEV No.	371232	Ref. No.	—
reducer TP flow rate 0.5l/min orange tolerance ±25%				
	GEV No.	371233	Ref. No.	—
reducer TP flow rate 0.8l/min white tolerance ±25%				
	GEV No.	371234	Ref. No.	—
reducer TP flow rate 1l/min light blue tolerance ±25%				
	GEV No.	371235	Ref. No.	—
reducer TP flow rate 1.2l/min brown tolerance ±25%				
	GEV No.	371236	Ref. No.	—
reducer TP flow rate 1.5l/min light brown tolerance ±25%				
	GEV No.	371237	Ref. No.	—
reducer TP flow rate 2.5l/min yellow tolerance ±25%				
	GEV No.	371238	Ref. No.	—
reducer TP flow rate 3.4l/min dark green tolerance ±25%				
	GEV No.	371239	Ref. No.	—
reducer TP flow rate 5l/min black tolerance ±25%				
	GEV No.	371240	Ref. No.	—
reducer TP flow rate 8l/min blue tolerance ±20%				
	GEV No.	503139	Ref. No.	—
solenoid valve filter ø 19.5mm H 16mm				

solenoid valves with reducers



1

GEV No.	370142	Ref. No.	1542
description	solenoid valve double straight 230VAC inlet 3/4" outlet 11.5mm output B 0.6l/min		

pressure switches

for warewashing

ø 58mm with male faston 6.3mm

with connection horizontal



1

GEV No.	541140	Ref. No.	4054
description	pressure control pressure range 55/30mbar connection 6mm ø 58mm pressure connection horizontal warewashing		

pumps

wash and rinse pumps

FIR

pumps



1



GEV No.	500457	Ref. No.	3823
description	pump inlet ø 28mm outlet ø 26mm type 2213.1417 230V 50Hz 1 phase 0.15kW 0.2HP L 198mm rotation direction left capacitor 6.3µF FIR		
spare parts for	500457		



GEV No.	365012	Ref. No.	—
description	operating capacitor capacity 6.3µF 450V tolerance 5% 50Hz ambient temperature max. -25 to +85°C ø 30mm L 61mm M8 plastic connection male faston 6.3mm protection		

Table continues overleaf



spare parts for 500457			
	GEV No.	510384	Ref. No. —
pump cover inlet ø 28mm outlet ø 26mm ø 100mm ID ø 76mm			
	GEV No.	510695	Ref. No. —
mechanical shaft seal height counter ring 5.5mm ID ø 11mm			
	GEV No.	521703	Ref. No. —
pump cover gasket EPDM thickness 2.5mm ID ø 75mm Qty 1 pcs			



1			
GEV No.	500683	Ref. No.	4718
description	pump inlet ø 60mm outlet ø 50mm type 2223.U150 230V 50Hz 1 phase 0.89kW 1.2HP L 260mm rotation direction right capacitor 16µF FIR		
spare parts for 500683			
	GEV No.	365021	Ref. No. —
operating capacitor capacity 16µF 425V tolerance 5% 50/60Hz ambient temperature max. -25 to +85°C ø 35mm L 73mm single M8 plastic connection male faston 6.3mm 416.10.99 protection			
	GEV No.	510552	Ref. No. —
pump cover gasket pump type 1292-2/3942/3981/3911/3983			
	GEV No.	510600	Ref. No. —
impeller ø 102mm H 29mm shaft intake ø 9/8mm rotation direction right blades 6			
	GEV No.	510692	Ref. No. —
mechanical shaft seal for shaft ø 11mm slide ring ext. ø 24mm slide ring H 13mm counter ring mounting ø 26mm height counter ring 8mm counter ring int. ø 14mm			
	GEV No.	521511	Ref. No. —
pump cover inlet ø 60mm outlet ø 50/30mm supporting pressure M12x1.75 supporting pressure open pump type 2233 turn direction right ø 160mm ID ø 120mm inner height 23mm			

OLYMPIA pumps



1			
GEV No.	500000	Ref. No.	4112
description	pump inlet ø 29mm outlet ø 28mm type T 4 230V 50Hz 1 phase 0.29kW 0.39HP L 202mm rotation direction left capacitor 8µF OLYMPIA		
spare parts for 500000			
	GEV No.	365013	Ref. No. —
operating capacitor capacity 8µF 400V tolerance 5%Hz ambient temperature max. -25 to +85°C ø 31.5mm L 55mm M8 plastic connection male faston 6.3mm protection			
	GEV No.	510554	Ref. No. —
O-ring EPDM thickness 2mm ID ø 120mm Qty 1 pcs			
	GEV No.	510693	Ref. No. —
mechanical shaft seal for shaft ø 12mm slide ring ext. ø 24mm slide ring H 15.5mm slide ring int. ø 11mm counter ring mounting ø 24mm height counter ring 8mm counter ring int. ø 13.5mm			
	GEV No.	521176	Ref. No. —
pump cover OLYMPIA inlet ø 1"mm outlet ø 28mm pump type T 4			
	GEV No.	521257	Ref. No. —
impeller ø 80mm H 12mm rotation direction left thread M10R shaft ø 12mm shaft length 7.5mm blades 6			











1			
GEV No.	500476	Ref. No.	1808
description	pump inlet ø 50mm outlet ø 30mm type T45 230V 50Hz 1 phase 0.33kW 0.45HP L 215mm rotation direction left capacitor 8µF OLYMPIA		
spare parts for 500476			
	GEV No.	365013	Ref. No. —
operating capacitor capacity 8µF 400V tolerance 5%Hz ambient temperature max. -25 to +85°C ø 31.5mm L 55mm M8 plastic connection male faston 6.3mm protection			

Table continues overleaf







spare parts for 500476				
	GEV No.	501312	Ref. No.	—
O-ring EPDM thickness 1.78mm ID ø 88.62mm Qty 1 pcs				
	GEV No.	510693	Ref. No.	—
mechanical shaft seal for shaft ø 12mm slide ring ext. ø 24mm slide ring H 15.5mm slide ring int. ø 11mm counter ring mounting ø 24mm height counter ring 8mm counter ring int. ø 13.5mm				
	GEV No.	521258	Ref. No.	—
impellor ø 80mm H 13mm thread M10R shaft ø 12mm shaft length 7.5mm blades 6				



1				
GEV No.	500477	Ref. No.	3730	
description	pump inlet ø 50mm outlet ø 40mm type T5 230V 50Hz 1 phase 0.35kW 0.48HP L 200mm rotation direction right capacitor 10µF OLYMPIA inlet ø 50mm outlet ø 40mm			
spare parts for	500477			
	GEV No.	365015	Ref. No.	—
operating capacitor capacity 10µF 400V tolerance 5%Hz ambient temperature max. -25 to +85°C ø 35.5mm L 59mm M8 plastic connection male faston 6.3mm protection				
	GEV No.	507458	Ref. No.	3731
impellor ø 90mm H 12mm rotation direction right thread M10L blades 8				
	GEV No.	510554	Ref. No.	—
O-ring EPDM thickness 2mm ID ø 120mm Qty 1 pcs				
	GEV No.	510693	Ref. No.	—
mechanical shaft seal for shaft ø 12mm slide ring ext. ø 24mm slide ring H 15.5mm slide ring int. ø 11mm counter ring mounting ø 24mm height counter ring 8mm counter ring int. ø 13.5mm				



1				
GEV No.	500475	Ref. No.	3350	
description	pump inlet ø 50mm outlet ø 48mm type T75 230V 50Hz 1 phase 0.55kW 0.75HP L 237mm rotation direction right capacitor 12.5µF OLYMPIA			
spare parts for	500475			
	GEV No.	365014	Ref. No.	—
operating capacitor capacity 12.5µF 450V tolerance 5%Hz ambient temperature max. -25 to +85°C ø 35mm L 70mm M8 plastic connection male faston 6.3mm 45S.C3D5.12.5 protection				
	GEV No.	510693	Ref. No.	—
mechanical shaft seal for shaft ø 12mm slide ring ext. ø 24mm slide ring H 15.5mm slide ring int. ø 11mm counter ring mounting ø 24mm height counter ring 8mm counter ring int. ø 13.5mm				
	GEV No.	521161	Ref. No.	—
pump cover OLYMPIA inlet ø 50mm outlet ø 48/31mm auxiliary pressure connection 10mm pump type T75				
	GEV No.	521162	Ref. No.	—
impellor ø 106mm H 22mm pump type T75 thread M10L				
	GEV No.	521727	Ref. No.	—
pump cover gasket EPDM thickness 1.78mm ID ø 145mm Qty 1 pcs				

drain pumps

ASKOLL



1				
GEV No.	500054	Ref. No.	3385	
description	drain pump inlet ø 24mm outlet ø 22mm 230V 40W 50Hz ASKOLL type R113			



electric accessories

terminals

connection boxes



1

GEV No.	550300	Ref. No.	4752
----------------	--------	-----------------	------

description	power terminal block 3-pole contacts P+N+E		
--------------------	--	--	--

equipmentspecific units

for dishwashers

drain and intake components

UNIVERBAR

drain /intake bodies



1

GEV No.	507449	Ref. No.	1536
----------------	--------	-----------------	------

description	drain fitting thread 1" hose ø 30mm		
--------------------	-------------------------------------	--	--

accessories for	507449		
------------------------	--------	--	--



GEV No.	517180	Ref. No.	—
----------------	--------	-----------------	---

description	nut thread 1" H 5mm WS 36 SS Qty 1 pcs		
--------------------	--	--	--



GEV No.	517181	Ref. No.	1535
----------------	--------	-----------------	------

description	flat gasket rubber ED ø 44mm ID ø 32mm thickness 3mm Qty 1 pcs		
--------------------	--	--	--



1

GEV No.	507460	Ref. No.	4621
----------------	--------	-----------------	------

description	drain fitting thread 1½" ED ø 78mm ID ø 50mm		
--------------------	--	--	--

overflow pipes



1

GEV No.	507466	Ref. No.	1534
----------------	--------	-----------------	------

description	overflow pipe L 107mm ø 28mm		
--------------------	------------------------------	--	--



1

GEV No.	517178	Ref. No.	2112
----------------	--------	-----------------	------

description	overflow pipe L 121mm ø 28mm		
--------------------	------------------------------	--	--



1

GEV No.	517606	Ref. No.	1201
----------------	--------	-----------------	------

description	overflow pipe L 149mm ø 51mm		
--------------------	------------------------------	--	--



1

GEV No.	507500	Ref. No.	3266
----------------	--------	-----------------	------

description	overflow pipe L 88mm ø 28mm		
--------------------	-----------------------------	--	--









containers

salt tanks



1

GEV No.	510929	Ref. No.	4333
description	salt tank ø 120mm H 117mm hose ø 10mm mounting ø 70mm overall height 157mm		
spare parts for	510929		
	GEV No.	506015	Ref. No. —
	O-ring EPDM thickness 3.53mm ID ø 39.69mm Qty 1 pcs		
	GEV No.	510018	Ref. No. —
	nut ø 92mm H 10.5mm for salt tank ID ø 64mm		
	GEV No.	524177	Ref. No. —
	lid ø 69mm H 20mm for salt tank ID ø 50mm		
accessories for	510929		
	GEV No.	510071	Ref. No. —
	flat gasket rubber ED ø 81mm ID ø 68mm thickness 3mm for salt tank Qty 1 pcs		
	GEV No.	510654	Ref. No. —
	gasket H 6mm D1 ø 82mm D2 ø 68mm		
	GEV No.	510883	Ref. No. —
	gasket rubber ED ø 86mm ID ø 66mm thickness 2mm for salt tank Qty 1 pcs		

boilers

boilers for dishwashers



1

GEV No.	507465	Ref. No.	3326
description	boiler without heating element ø 150mm L 415mm inlet ø 12mm outlet ø 2x 10mm		

softener cartridges

softening columns



1



GEV No.	530000	Ref. No.	4331
description	softener 4-fold L 380mm W 180mm		

air traps

air traps



1

GEV No.	507504	Ref. No.	4032 4032I
description	air trap ø 39mm H 35mm thread M8 hose ø 6mm plastic		
accessories for	507504		
	GEV No.	507447	Ref. No. 2017
	flat gasket PTFE ED ø 14mm ID ø 8mm thickness 2mm Qty 1 pcs		
	GEV No.	507448	Ref. No. 2018
	nut thread M8 H 8mm SS WS 13 Qty 1 pcs		



1

GEV No.	507505	Ref. No.	1360 1360I
description	air trap ø 39mm H 90mm thread M8 hose ø 6mm plastic		

backflow preventers

backflow preventers



1

GEV No.	516101	Ref. No.	4221
description	backflow preventer dishwasher hose ø 12mm		
spare parts for	516101		
	GEV No.	506367	Ref. No. —
	flat gasket rubber ED ø 40mm ID ø 28mm thickness 1.8mm Qty 1 pcs		



door mechanics

miscellaneous



1

GEV No.	504428	Ref. No.	3282
----------------	--------	-----------------	------

description	bush for door brass ED \varnothing 10/12mm ID \varnothing 8mm H 5mm		
--------------------	---	--	--

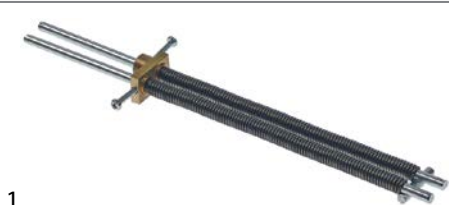

1

GEV No.	507450	Ref. No.	1598
----------------	--------	-----------------	------

description	spring for door		
--------------------	-----------------	--	--

washing and rinsing systems



1

GEV No.	517609	Ref. No.	2528
----------------	--------	-----------------	------

description	bush for rinse arm PTFE L 10.6mm D1 \varnothing 14mm D2 \varnothing 16.5mm ID \varnothing 10mm		
--------------------	--	--	--

washing and rinsing systems (sorted by producer)

UNIVERBAR



1

GEV No.	507502	Ref. No.	2540
----------------	--------	-----------------	------

description	wash and rinse arm wash arm L 385mm rinse arm L 385mm w. jets 12 r. jets 4 mounting \varnothing 10/32mm mounting pos. upper/lower L 390mm W 390mm		
--------------------	---	--	--



1

GEV No.	507581	Ref. No.	2541
----------------	--------	-----------------	------

description	wash and rinse arm wash arm L 430mm rinse arm L 425mm w. jets 12 r. jets 5		
--------------------	--	--	--

spare parts for	507581		
------------------------	--------	--	--



1

GEV No.	505045	Ref. No.	—
description	O-ring EPDM thickness 1.78mm ID \varnothing 5.28mm Qty 1 pcs		

spare parts for	507581		
------------------------	--------	--	--



1

GEV No.	510893	Ref. No.	—
----------------	--------	-----------------	---

description	O-ring EPDM thickness 2.62mm ID \varnothing 9.92mm Qty 1 pcs		
--------------------	--	--	--



1

GEV No.	517092	Ref. No.	—
----------------	--------	-----------------	---

description	guide for rinse arm shaft		
--------------------	---------------------------	--	--



1

GEV No.	517101	Ref. No.	—
----------------	--------	-----------------	---

description	gasket PTFE ED \varnothing 16mm ID \varnothing 10mm thickness 2.5mm Qty 1 pcs		
--------------------	---	--	--



1

GEV No.	517102	Ref. No.	—
----------------	--------	-----------------	---

description	rinse arm shaft		
--------------------	-----------------	--	--



1

GEV No.	517103	Ref. No.	—
----------------	--------	-----------------	---

description	cover		
--------------------	-------	--	--



1

GEV No.	517104	Ref. No.	—
----------------	--------	-----------------	---

description	O-ring EPDM thickness 2.62mm ID \varnothing 31.42mm Qty 1 pcs		
--------------------	---	--	--



1

GEV No.	517408	Ref. No.	—
----------------	--------	-----------------	---

description	pipe for wash arm ED \varnothing 42mm L 150mm plastic mounting \varnothing 28mm ID \varnothing 10mm		
--------------------	---	--	--



1

GEV No.	517609	Ref. No.	2528
----------------	--------	-----------------	------

description	bush for rinse arm PTFE L 10.6mm D1 \varnothing 14mm D2 \varnothing 16.5mm ID \varnothing 10mm		
--------------------	--	--	--



1

GEV No.	560536	Ref. No.	2535
----------------	--------	-----------------	------

description	Thumb screw thread M8 thread L 5mm \varnothing 20mm H 10mm SS Qty 1 pcs		
--------------------	---	--	--



1

GEV No.	507507	Ref. No.	3342
----------------	--------	-----------------	------

description	wash and rinse arm wash arm L 503mm rinse arm L 475mm w. jets 10 r. jets 6 mounting \varnothing 10/32mm mounting pos. upper/lower		
--------------------	---	--	--



1

GEV No.	507468	Ref. No.	4080
----------------	--------	-----------------	------

description	end cap for rinse arm thread M10x1 H 8mm chrome-plated brass		
--------------------	--	--	--



1

GEV No.	503317	Ref. No.	4022
----------------	--------	-----------------	------

description	rinse jet H 13mm thread M6x1 WS 10 conical seal		
--------------------	---	--	--





1

GEV No.	507446	Ref. No.	2530
----------------	--------	-----------------	------

description	wash arm boss		
--------------------	---------------	--	--







			
1			
GEV No.	507506	Ref. No.	3105
description	wash and rinse arm wash arm L 485mm rinse arm L 470mm w. jets 6 r. jets 6 mounting ø 10/43mm mounting pos. upper/lower		

			
1			
GEV No.	507468	Ref. No.	4080
description	end cap for rinse arm thread M10x1 H 8mm chrome-plated brass		

			
1			
GEV No.	503317	Ref. No.	4022
description	rinse jet H 13mm thread M6x1 WS 10 conical seal		

			
1			
GEV No.	517607	Ref. No.	3109
description	wash arm boss mounting ø 10mm ø 28mm L 77mm W 70mm H 49mm		

			
1			
GEV No.	507501	Ref. No.	3259
description	rinse arm L 375mm nozzles 4 mounting ø 10mm mounting pos. upper		
spare parts for	507501		
	GEV No.	503317	Ref. No. 4022
	rinse jet H 13mm thread M6x1 WS 10 conical seal		
	GEV No.	507468	Ref. No. 4080
	end cap for rinse arm thread M10x1 H 8mm chrome-plated brass		

			
1			
GEV No.	507468	Ref. No.	4080
description	end cap for rinse arm thread M10x1 H 8mm chrome-plated brass		

			
1			
GEV No.	503317	Ref. No.	4022
description	rinse jet H 13mm thread M6x1 WS 10 conical seal		

			
1			
GEV No.	517608	Ref. No.	3336
description	wash arm support complete mounting pos. lower thread M8x1.25 ø 35mm H 360mm		

			
1			
GEV No.	507503	Ref. No.	1918
description	wash arm support mounting pos. lower		

			
1			
GEV No.	507467	Ref. No.	4745
description	wash arm support mounting pos. lower ø 35mm H 235mm hose ø 33mm		

knobs

producer-specific knobs

UNIVERBAR

			
1			
GEV No.	110949	Ref. No.	3321
description	knob thermostat t.max. 90°C 0-90°C ø 42mm shaft ø 6x4.6mm shaft flat upper black		



accessories

rosettes



GEV No.	112195	Ref. No.	3322
description	rosette knob knob ø 42mm ø 56mm		

sealing washers

rubber gaskets



GEV No.	517181	Ref. No.	1535
description	flat gasket rubber ED ø 44mm ID ø 32mm thickness 3mm Qty 1 pcs		

gaskets

O-rings

EPDM

ø1.78mm



GEV No.	517035	Ref. No.	3285
description	O-ring EPDM thickness 1.78mm ID ø 4.48mm Qty 1 pcs		

ø2.62mm



GEV No.	511511	Ref. No.	3154
description	O-ring EPDM thickness 2.62mm ID ø 17.13mm Qty 10 pcs		



GEV No.	505192	Ref. No.	3337
description	O-ring EPDM thickness 2.62mm ID ø 39.34mm Qty 1 pcs		

ø5.34mm



GEV No.	510408	Ref. No.	4011
description	O-ring EPDM thickness 5.34mm ID ø 47mm Qty 1 pcs		

PTFE gaskets



GEV No.	507447	Ref. No.	2017
description	flat gasket PTFE ED ø 14mm ID ø 8mm thickness 2mm Qty 1 pcs		

dosing pumps

peristaltic dosing pumps

SEKO

wall-mounted version

with speed control



GEV No.	361156 ¹	Ref. No.	4801
description	dosing pump SEKO speed control 0.6-4l/h 230VAC detergent hose ø 4x6mm hose type K hose Santoprene suction level 1.5m type PR wall-mounted version dimensions 103x82x92mm		

spare parts for 361156

	GEV No.	361136	Ref. No.	—
		roller assembly for dosing pump hole ø 4.8x4mm		

	GEV No.	361815	Ref. No.	—
		pump hose detergent hose ø 6x10mm hose ø 4x6mm hose type K hose Santoprene type SEKO		

	GEV No.	362034	Ref. No.	—
		pump cover for dosing pump plastic SEKO		

accessories for 361156

	GEV No.	361142	Ref. No.	—
		mounting set detergent hose type 4x6mm hose length 2m PVC 2x hose/container filter/tank intake transparent		

	GEV No.	361891	Ref. No.	—
		mounting set detergent hose type 4x6mm hose length 2m PVC 2x hose/container filter/tank intake transparent		

	GEV No.	520090	Ref. No.	—
		PVC hose ID ø 4mm ED ø 6mm L 2m thickness 1mm t.max. 60°C transparent		

¹with accessories
Table continues overleaf



accessories for 361156			
	GEV No.	520091	Ref. No. —
nylon hose ID ø 4mm ED ø 6mm L 2m thickness 1mm operating p. 10bar burst p. 50bar t.max. 100°C transparent			









built-in version

with frequency control



GEV No.	361767 ¹	Ref. No.	1916
description	dosing pump SEKO 3l/h 230VAC detergent hose ø 4x6mm hose type K hose Santoprene suction level 1.5m type NBR 3 8W built-in version peristaltic pump		
spare parts for 361767			
	GEV No.	361815	Ref. No. —
pump hose detergent hose ø 6x10mm hose ø 4x6mm hose type K hose Santoprene type SEKO			

¹incl. inlet and conveyor hose

accessories for 361535			
	GEV No.	361553	Ref. No. —
membrane EPDM			
	GEV No.	361700	Ref. No. —
hose connector rotary hose ø 4x6mm plastic connection M10x1			
	GEV No.	361701	Ref. No. —
hose connector thread M10x1 grommet ø 7.5mm			
	GEV No.	361703	Ref. No. —
hose connector thread M10x1 brass pipe connection ø 4x6mmmm			
	GEV No.	361704	Ref. No. —
hose connector brass straight thread M12x1 hose ø 11mm Qty 1 pcs			
	GEV No.	510296	Ref. No. —
membrane silicone			
	GEV No.	520090	Ref. No. —
PVC hose ID ø 4mm ED ø 6mm L 2m thickness 1mm t.max. 60°C transparent			
	GEV No.	520091	Ref. No. —
nylon hose ID ø 4mm ED ø 6mm L 2m thickness 1mm operating p. 10bar burst p. 50bar t.max. 100°C transparent			

membrane dosing pumps

self-priming with supporting pressure

GERMAC

type 2000



GEV No.	361535	Ref. No.	4096
description	dosing pump type 2000 rinse aid inlet 4x6mm outlet M10x1 suction connection ø 4x6mm supporting pressure 11mm rebound ball PTFE 1mm GERMAC CODE VNR/U3		
spare parts for 361535			
	GEV No.	361550	Ref. No. —
hose connector hose ø 4x6mm			
	GEV No.	361551	Ref. No. —
compression spring wire gauge ø 1mm			
	GEV No.	361702	Ref. No. —
hose connector brass hose ø 4x6mm			
	GEV No.	361705	Ref. No. —
gasket for hose connector M12x1			
	GEV No.	510298	Ref. No. —
lip valve dosing pump suitable for DB2/DS5			
accessories for 361535			
	GEV No.	361142	Ref. No. —
mounting set detergent hose type 4x6mm hose length 2m PVC 2x hose/container filter/tank intake transparent			

accessories

container filters





GEV No.	361905	Ref. No.	1040
description	container filter plastic hose ø 5mm detergent		

hoses

supply hoses

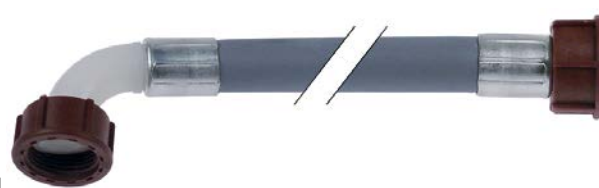
PVC supply hoses



GEV No.	520010	Ref. No.	3204
description	supply hose PVC straight-curved DN13 connections 3/4" L 1500mm operating p. 10bar burst p. 32bar t.max. 90°C blue approval VDE flat seal		
accessories for 520010			
	GEV No.	520053	Ref. No. —
screen connection 3/4" D1 ø 26mm D2 ø 15mm Qty 10 pcs rubber thickness 8mm			
	GEV No.	520054	Ref. No. —
flat gasket rubber ED ø 23.5mm ID ø 14mm thickness 2.3mm Qty 10 pcs			



drain hoses

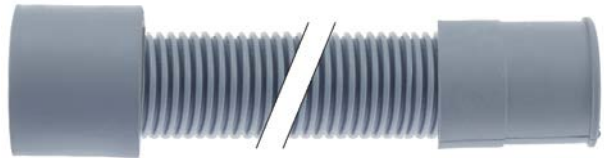

1

GEV No.	511205	Ref. No.	1604
description	drain hose DN19 L 1500mm A int. ø 23mm A ext. ø 29mm B int. ø 29mm outer hose ø 29mm B ext. ø 35mm		

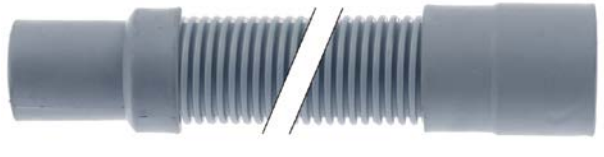

1

GEV No.	530574	Ref. No.	4717
description	drain hose DN31 L 2000mm A int. ø 31mm A ext. ø 35mm B int. ø 41mm B ext. ø 45mm outer hose ø 38mm		

nuts

hexagonal nuts

DIN 6923 / ISO 4161



1

GEV No.	507448	Ref. No.	2018
description	nut thread M8 H 8mm SS WS 13 Qty 1 pcs		

hexagonal nuts metric (without norm)



1

GEV No.	507461	Ref. No.	1505
description	hexagonal nut thread M10x1 H 3mm WS 17 SS Qty 1 pcs		

hexagonal nuts inch thread



1

GEV No.	507459	Ref. No.	1533
description	nut thread 1" H 5mm WS 36 SS Qty 1 pcs		

measuring equipment

thermometers

built-in thermometers



1

GEV No.	541086	Ref. No.	4507
description	thermometer mounting measurements 58x25.5mm 0 up to +120°C capillary pipe 2000mm probe ø 6mm probe L 23mm		

fastening material

screws

knurled screws



1

GEV No.	560536	Ref. No.	2535
description	Thumb screw thread M8 thread L 5mm ø 20mm H 10mm SS Qty 1 pcs		

